

SolarTemp® 850

-60...650 °C



Highlights

- No cabling or battery change necessary → Supply via integrated solar cell
- Robust mechanical construction → Reliable and long-lasting operation
- Insensitive to electromagnetic interference → Additional EMC shielding
- Optional integrable transmitters → Simple integration into process control system
- Two separate measuring circuits and continuous self-test → Maximum operational reliability

Technical data	
Version	Straight
Dimensions	
→ Housing	140 x 150 x 30 (W x H x D)
→ With mounting plate	170 x 150 x 35 (W x H x D)
Measuring range	-60...650 °C
Medium / Application	Liquid and gaseous media
Display	3½ digit, 7 segment LCD, 25 mm high
Resolution	0.1 K in the range <200 °C 1 K in the range >200 °C
Measuring rate	3 s
Medium temperature	See selected measuring range
Ambient temperature	5...60 °C
Storage temperature	5...60 °C
Degree of protection EN 60529	IP65
Approvals	
EU RO Mutual Recognition Type Approval Certificate (Covers: ABS, BV, CCS, CRS, DNV, IRS, KR, LR, ClassNK, PRS, RINA, RS)	

Electrical data	
Measuring element	Pt1000 / 2-wire / Class B
Accuracy	±1 % of range ±1 digit
Electrical connection	4-pin plug connector M12 x 1
Supply voltage	Solar cell, 80 lux
Analogue output	
Current signal	4...20 mA / 2-wire (loop supply 15...26 VDC)
Scaling	Measuring range
Signal error	Error signal according to NAMUR NE43
Burden	Max. 500 Ω

Technical drawings

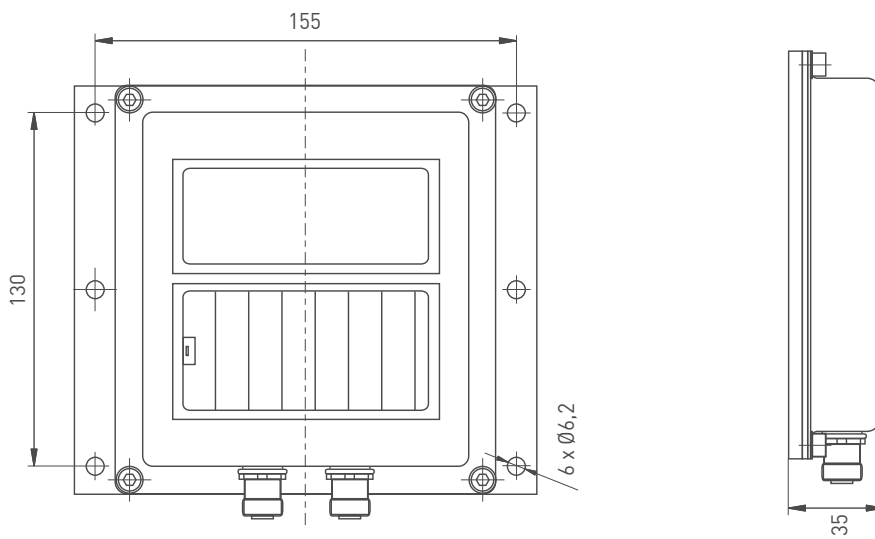

Materials

Materials	
Not in contact with medium	
Housing	Powder-coated steel, glass front window

Article numbers

Order code		
Type	Display range	Order number
Standard version	-60...650 °C	85065P54
Transmitter version	4...20 mA 0...600 °C	85065P53360
Transmitter version	4...20 mA 0...300 °C	85065P53330



BEST
SELLER

Type	Order number
850 Standard version, -60...650 °C	85065P54
Transmitter version, 4...20 mA, 0...600 °C	85065P53360
Transmitter version, 4...20 mA, 0...300 °C	85065P53330

Accessories



Connection cable

Order code			
Accessories		Length	Order number
	Sensor cable	3 m	XPV108
	Connection cable with cable plug M12 x 1, 4 pin version, shielded	5 m	XPV109
		10 m	XPV110
	Cable: FEP cable 4 x 0.5 mm ²	15 m	XPV158
	Transmitter cable	10 m	XPV150
	Connection cable with cable socket M12 x 1, 4 pin version, shielded	15 m	XPV167
	Cable: FEP cable 4 x 0.5 mm ²		

Measuring point designation

Laser-inscribed stainless steel plate with fixing wire for easy attachment to measuring points

- **Scope of delivery:** Designation plate inscribed according to specification and enclosed fixing wire (sealing wire)
- **Fastening:** Wire (included in delivery), alternatively sealing, cable ties or similar (not included in delivery)
- **Materials:** Plate stainless steel 1.4571, wire stainless steel
- **Dimensions:** Plate 55 x 10 x 0.8 mm, wire length 180 mm
- **Inscription:** one-sided, single-line, max. 11 characters, character height 5 mm, designation width max. 40 mm, letters, numbers, symbols, barcodes, QR codes
- **Transmission of designations:** digital list, file formats Excel, Word or CSV

ONSITETAG

